

CH7200 **VISLIDER**[®] Attachment

Model : CH7241DE



Instruction manual (with warranty card)

◆ Safety precautions ◆



WARNING

Denotes risk of personal injury, loss of life or damage to the tool
In case of nonobservance of the instructions in this manual.

- ① Before use, be sure to carefully read the instructions. Read the related screwdriver instruction manual, too.
- ② Be sure to wear protective goggles during work.
- ③ Be sure to wear a dust-proof mask during work.
- ④ Depending on the work environment, wear ear protectors, hardhat, working shoes, and other safety gear.
- ⑤ Be sure to use the specified Adaptor Kit that is dedicated to your screwdriver model.
- ⑥ Be sure to use the specified "VISROPE STRIPS" connecting screws.
- ⑦ Ensure solid footing and hold yourself in a safety-first position.
- ⑧ Wear clothes proper for work.
- ⑨ Keep the workplace in order and well lit.
- ⑩ When working in an elevated place, make sure there is nobody beneath. Be very careful not to let this unit and screws fall.
- ⑪ Never direct this unit toward anybody.
- ⑫ Never keep your hands, feet and head close to the tip (screw outlet) of the unit during work.
- ⑬ Keep the unit away from open fire and flame.
- ⑭ Do not use the unit near volatile, flammable substances such as gasoline, thinner, gas, paint, and adhesive. The unit may catch fire or explode.
- ⑮ Do not use the unit in rain, or water-splashed, wet or humid area. Do not leave the unit in rain, either.
- ⑯ Keep the unit, accessories and consumable parts without reach of children.
- ⑰ For after-use handling, refer to "Maintenance and inspection".
- ⑱ Handle the unit with enough care. Dropping or hitting may result in malfunction.
- ⑲ Keep these instructions in the safe place.

◆ Specifications ◆

MODEL: CH7241DE

Length (without accessories)	Approx. 216 mm (8 1/2 ")	
Weight (without accessories)	Approx. 370 g	
Depth adjustment (countersunk and flat-head screws)	-6 mm (-1/8 ") (shallow) +7 mm (+1/8 ") (deep)	
Applicable screw lengths	Countersunk and flat-head screws	25 to 41 mm (1" to 1 5/8")
	Pan-head drilled screws	19 mm (3/4")

◆Parts designation◆

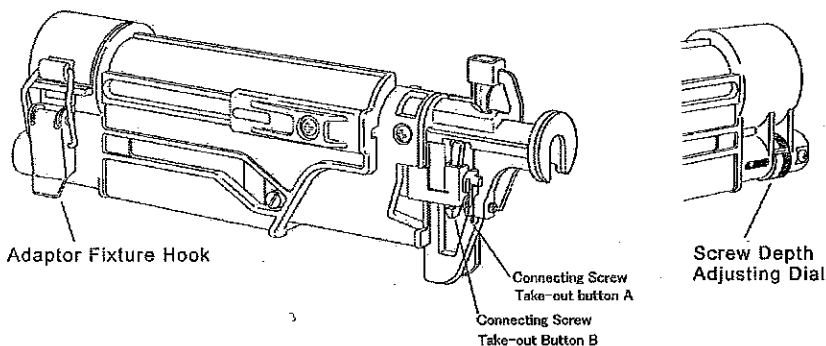

Adaptor kit for the CH7241

* Not included in this product, but separately sold. (Available in different types for different screwdrivers)

Motor Adaptor



Socket



CH7241 Genuine Bit



(available in different types)

◆Setting up the specific adaptor kit◆

The way to mount the kit is somewhat different depending on the manufacturer and type of your screwdriver. Refer to "How to mount by screwdriver type" that comes with the specific adaptor kit.

◆Attaching and detaching the specific bit◆

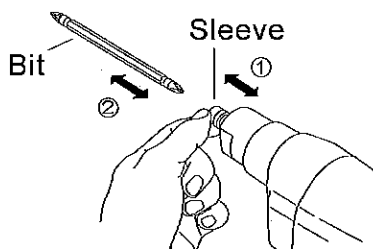

Attaching ①Pull the sleeve toward the screwdriver.

②Insert the bit into the socket and push the sleeve back into place.

※Make sure the bit is tight enough in position.

Detaching ①Pull the sleeve toward the screwdriver.

②Draw out the bit.

※The CH7241 genuine bit, which comes with the specific adaptor kit, is of double-head type. When one of the heads has worn out, use the other side. Replace the bit when both the heads have worn out.

◆Mounting and dismounting the attachment◆

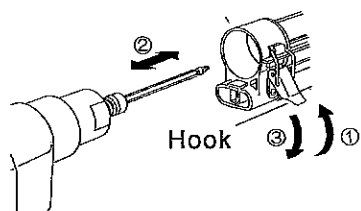

Mounting ①Tilt up the hook.

②Insert the screwdriver's adaptor into this attachment.

※Make sure the bit comes in together.

Dismounting ①Tilt down the hook.

①Tilt up the hook.

②Draw the screwdriver's adaptor out of this attachment.

◆ Adjusting the screw-driving depth ◆

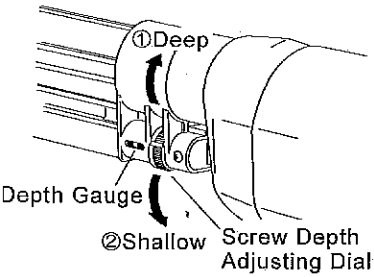

- ① Turn the screw depth adjusting dial upward to achieve more depth.
 - ② Turn the screw depth adjusting dial downward to achieve less depth.
- ※ Four clicks make an increment of 1 mm.

Approximate standard depths (0 mm deep)

Countersunk and flat-head screws

Pan-head screws

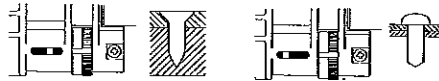

◆ Attaching and detaching the specific connecting screws ◆

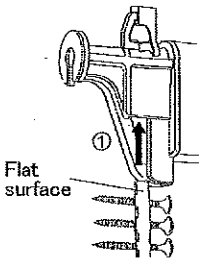

Attaching

- ① Place the VISROPE STRIPS in the direction shown in the figure.

Detaching

- ② Hold down the connecting screw take-out button A and B simultaneously.
- ③ Draw out the VISROPE STRIPS.

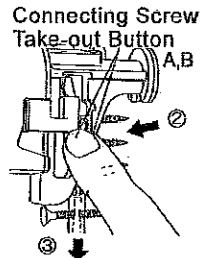

◆ Tightening the screws ◆

perpendicularly !

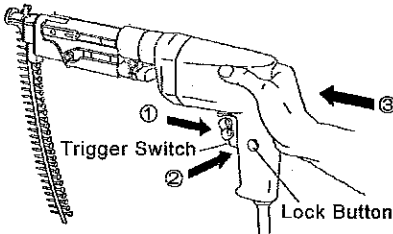

- ① Set the screwdriver's trigger switch to the ON position.
- ② Press the lock button for continuous screw tightening.
- ③ Apply and push the tool perpendicular onto the work. The CH7241 stops at the end of a stroke. The screwdriver's clutch is then activated to completely tighten up the screw.

◆ Troubleshooting ◆

- Two screws fed at once, or screw jammed and stuck.

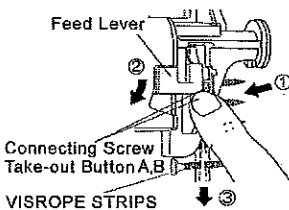

- ① Hold down the connecting screw take-out button A and B simultaneously.
- ② Lower the feed lever.
- ③ Make sure the screws go smoothly, and draw out the VISROPE STRIPS.

◆ Maintenance and inspection ◆

1. After each use, be sure to clean up the unit. Powder plaster, dust and dirt stuck on the unit may get it in trouble.
2. To wipe the unit clean, use dry cloth or neutral detergent-soaked cloth. Do not use gasoline, thinner or the like, which would damage the unit. Never wash the unit in water, which would get it rusty or malfunctioning.
3. The bit of the specific adaptor kit is consumable. If its both heads have worn out, immediately replace it with new one. ※Worn-out bit may cause poor tightening or damage the screw head.
4. Store the unit in a dry, cool place. Keep it without reach of children. Avoid any unstable spot to store the unit on.
5. Do not disassemble and repair the unit yourself. For repairs, contact your dealer.

VISLIDER Auto Feed Screwdriving Attachment

CH7000 Attachment Warranty Card

Model	CH7241DE	Warranty period	6 month after date of purchase
Date of purchase			
※Customer	Names		
	Address		
	Phone		
※Dealer	Address		
	Name		
	Phone		

※Make sure that the above form is filled out. This warranty shall be invalid if the *-marked information is missing.

1. If within the warranty period the unit fails due to defect in material or workmanship, the manufacturer will repair the unit free of charge.
2. To ask for free repair within the warranty period, please take the unit and this warranty card with you to your dealer.
3. Even within the warranty period, the following cases are not covered by this warranty.
 - a) Troubles or damages due to wrong handling and use or through tampering with the unit.
 - b) Troubles or damages due to dropping or rough handling during moving or transport.
 - c) Troubles or damages due to fire, earthquake, flood, lightning, and other natural disasters and pollution.
 - d) Troubles or damages due to poor storage and negligence in maintenance.
 - e) Loss or missing of this warranty card.
 - f) No date of purchase, customer's names and address, or dealer's name and address entered in this warranty card. Or forged document.
4. If you want an engineer sent to you for repairing this product, you will be charged for his or her travel expenses and labor.
5. This warranty card will never be reissued. Keep it in a safe place.

● This warranty covers free repairs within the written warranty period and under the condition of proper use. This card is not intended to restrict the user's legal rights. For repairs after the warranty period, contact your dealer or the Customers' Services of MURO NORTH AMERICA INC. or MURO CORPORATION.

MURO CORPORATION

KIYOHARA FACTORY
7-1, Kiyohara Industrial Park

Utsunomiya-shi Tochigi-ken, JAPAN 321-3231

TEL: +81(028)667-7148 FAX: +81(028)667-47953

MURO NORTH AMERICA INC.

7 Tilbury Cr., Brampton, Ontario, CANADA L6T 3T4

TEL: (905) 451-7667 FAX: (905) 451-7936

7241DM01E - 2012.11.21

Printed in Japan